



MT Series

—— Remote Meter

User Manual



Models:MT11

Contents

1.Important Safety Instructions.....	1
2.Overview.....	2
3.Product classification	3
4. Installation	4
4.1 Base of MT11 (Optional accessory)	4
4.2 Wall installation steps	5
4.3 Surface mounting steps	7
5.Product Features	8
5.1 Front View	8
5.2 Rear View.....	9
6.Display and operation	11
6.1LCD display	11
6.2 Auto global view mode.....	12
6.3 Temperature units.....	14
6.4 Clear the generated energy	14
6.5 Battery type	15
6.6 Fault indication	19
7.Technical Specifications	20

1. Important Safety Instructions

Thank you for selecting the remote meter.

General safety information

- Please contact our company or transportation if the product has been damaged.
- Please read this manual carefully before using the product and pay attention to the safety information.
- Keep the product away from rain, exposure, severe dust, vibrations, corrosive gas and intense electromagnetic interference.
- Do not allow water to enter the product.
- There are no serviceable parts inside the product. Do not disassemble or attempt to repair it.

Recommendations

- The MT11 is only allowed to connect with DR N series charge controller. Please confirm before purchase and installation.
- Please do not install MT11 in a situation with strong electromagnetic interference.

2. Overview

The MT series remote meter is an accessory which is compatible with the DuoRacer series controller. It can monitor the running data and working status of the controller via the remote meter. The remote meter can browse the controller's parameters, set the battery type and temperature unit, and clean the generated energy. It is suitable for RV, Camper, Boat, and so on.

Features:

- Automatically identify and display the type, model and relevant parameter data of controllers.
- Real-time display the operational data and working status of the connected devices in digital, graphics and textual forms by a large-screen multifunction LCD.
- Three touch buttons are easy and quick to operate.
- No need for external power supply. Charge controller supply the power for MT11.
- It can browse the controller's parameters, set the battery type and temperature unit, and clean the generated energy.
- Real-time display of failure information of the connected devices.
- Longer communication distance based on RS485.

3.Product classification

- 1) MT11(include the 1.5m communication cable)
 - ✦ Remote meter MT11
 - ✦ 1.5m communication cable
(Model: CC-RS485-RS485-3.81-4P-150)
 - ✦ Base of MT11
- 2) MT11 (include the 5m communication cable)
 - ✦ Remote meter MT11
 - ✦ 5m communication cable
(Model: CC-RS485-RS485-3.81-4P-500)
 - ✦ Base of MT11
- 3) MT11 (include the 10m communication cable)
 - ✦ Remote meter MT11
 - ✦ 10m communication cable
(Model:CC-RS485-RS485-3.81-4P-1000)
 - ✦ Base of MT11
- 4) MT11(Do not include the communication cable)
 - ✦ Remote meter MT11
 - ✦ 1.5m communication cable
(Model: CC-RS485-RS485-3.81-4P-150)
 - ✦ Do not include Base of MT11

NOTE: The user can purchase the product according to the requirement.

4. Installation

4.1 Base of MT11 (Optional accessory)

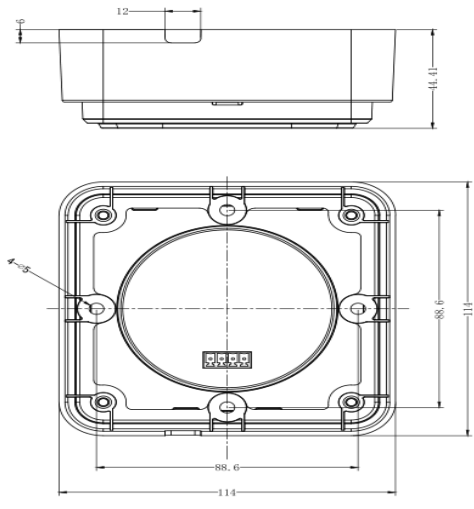

Mechanical parameter	Parameter
Overalldimension	114 x 114 x 44.41mm
Mountingdimension	88.6 x 88.6mm
Terminal	Φ5

4.2 Wall installation steps

Step1:

Locate and drill screw holes based on the Frame Mounting dimension of the base,and erect the plastic expansion bolts.

Step2:

Use four PA4.2x32 self-tapping screws to fix the Frame.

Step3:

Remove the decorative shell.

Step4:

Use four M4x8 pan head screws to mount MT11 Surface on the Frame.

Step5:

Install the decorative shell.

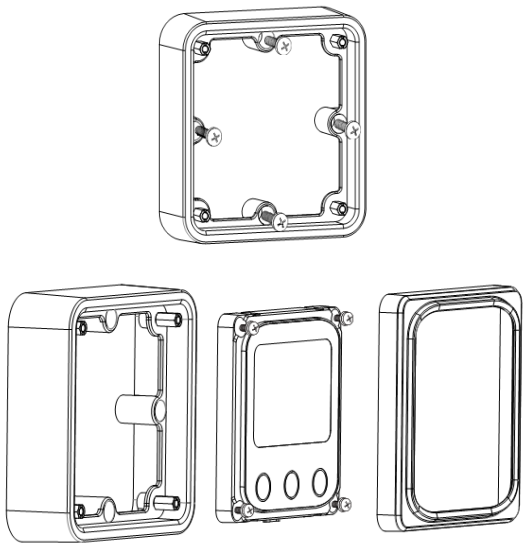

4.3 Surface mounting steps

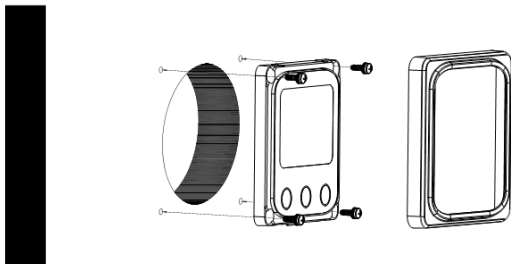

Step1: Locate and drill screw holes based on the installation size of the surface.

Step2: Remove the decorative shell

Step3: Use four M4x8 cross recessed pan head screws with M4 nuts to mount MT11 surface onto the panel.

Step4: Install the decorative shell

NOTE: Take full consideration of the plugging/unplugging space of the communication cable and the length of the cable during installation to see if they are appropriate.

5.Product Features

5.1 Front View

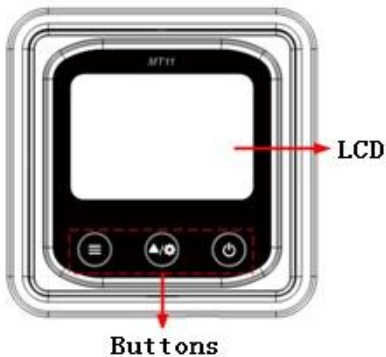



LCD display screen

Man-machine interaction operation interface. Refer to the chapter 5 display and operation

Buttons

The meter buttons include two function buttons and one switch button.

	Press the button	1.PV array parameters 2.Storage battery parameters 3.Browse the start battery parameters automatically (<i>Auto</i>)
	Press the button	Browse the PV array parameters Browse the Storage battery parameters Browse the start battery parameters
	Press the button and hold on 5s	Temperature units Battery type
	Press the button	The meter is powered ON
	Press the button and hold on 5s	The meter is powered OFF

5.2 Rear View

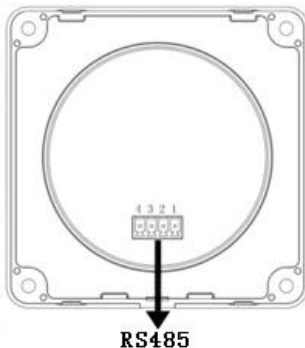

✦ **RS485communicationport**

It is used to connect the controller which Power the MT11.

✦ **Communicationcable's models**

CC-RS485-RS485-3.81-4P-150(Included)

CC-RS485-RS485-3.81-4P-1000(Optional)

CC-RS485-RS485-3.81-4P-2000(Optional)

✦ **Pins definition**

PIN	Definition
1	DC5V
2	RS-485-B
3	RS-485-A
4	GND

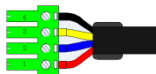





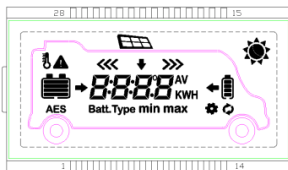





6.Display and operation

6.1LCD display



Icon	Instruction	Icon	Instruction
	BATT1 battery capacity level ^⓪ 0~12%		BATT2battery capacity level ^⓪ 0~12%
	BATT1battery capacity level ^⓪ 13~35%		BATT2battery capacity level ^⓪ 13~35%
	BATT1battery capacity level ^⓪ 36~61%		BATT2battery capacity level ^⓪ 36~61%
	BATT1battery capacity level ^⓪ 62~86%		BATT2battery capacity level ^⓪ 62~86%
	BATT1battery capacity level ^⓪ 87~100%		BATT2battery capacity level ^⓪ 87~100%
	Day		PV array

	Night		BATT1 charging icon
	Display the parameters of PV		BATT2charging icon
	Display the parameters of BATT1		BATT1temperature parameters
	Display the parameters of BATT2	AES	AES signal icon
	Setting icon	Batt.Type	Battery type icon
	Auto global view sign	min	Minimum voltage icon
	Fault Icon	max	Maximum voltage icon

①Battery power capacity is calculated by the linear relationship between the disconnect voltage of low voltage and float charging voltage.

6.2 Auto global view mode

Operation:

Step1: Press the  button, *Auto* is appear.

Step2: Press the  button, select the .

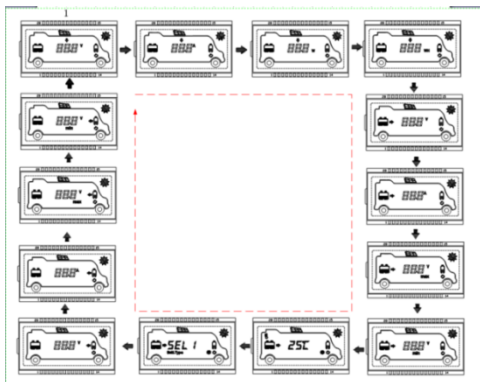

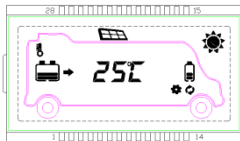

Echo Loop: PV voltage — PV current — PV power — Battery power — BATT1 voltage — BATT1 current — Max. BATT1 voltage — Min. BATT1 voltage — BATT1 temperature — BATT1 battery type — BATT2 voltage — BATT2 current — Max. BATT1 voltage — Min. BATT2 voltage — PV voltage

6.3 Temperature units



Operation:



Step1: Press the  button under the battery temperature interface.

Step2: Press the  button to select the temperature unit.

Step3: Press the  button to set successfully.

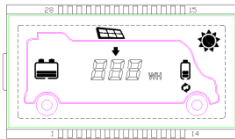
6.4 Clear the generated energy



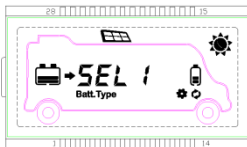

Press the  and  button and hold on 5s to clear the generated energy.

6.5 Battery type



1) Operation:

Step1: Press the  button and hold 5s under the battery type interface.

Step2: Press the  button when the battery type interface is flashing.

Step3: Press the  button to confirm the battery type.

2) Battery type

SEL 1	BATT112V Sealed	SEL 2	BATT124V Sealed
GEL 1	BATT112V Gel	GEL 2	BATT124V Gel
FLd 1	BATT112V Flooded	FLd 2	BATT124V Flooded
LiFe4	LiFePO ₄ (4S)	LiFB	LiFePO ₄ (8S)
LiC3	Li-NiCoMn (3S)	LiC6	Li-NiCoMn (6S)
USE	User		

 **CAUTION:** The battery voltage is set as default and not changeable when selecting the default battery type. Please change to “User” battery type before adjusting the battery voltage.



CAUTION: Set the voltage of the “User” battery type via PC software only.

1) Lead-acid Battery Control Voltage Parameters

The parameters are in the 12V system at 25 °C. Please double the values in the 24V system.

Battery type Voltage parameter	Sealed	Gel	Flooded	User
Over Voltage Disconnect Voltage	16.0V	16.0V	16.0V	9~17V
Charging Limit Voltage	15.0V	15.0V	15.0V	9~17V
Over Voltage Reconnect Voltage	15.0V	15.0V	15.0V	9~17V
Equalize Charging Voltage	14.6V	—	14.8V	9~17V
Boost Charging Voltage	14.4V	14.2V	14.6V	9~17V
Float Charging Voltage	13.8V	13.8V	13.8V	9~17V
Boost Reconnect Charging Voltage	13.2V	13.2V	13.2V	9~17V
Low Voltage Reconnect Voltage	12.6V	12.6V	12.6V	9~17V
Under Voltage Warning Reconnect Voltage	12.2V	12.2V	12.2V	9~17V
Under Volt. Warning Voltage	12.0V	12.0V	12.0V	9~17V
Low Volt. Disconnect Voltage	11.1V	11.1V	11.1V	9~17V
Discharging Limit Voltage	10.6V	10.6V	10.6V	9~17V
Equalize Duration (min.)	120	—	120	0~180
Boost Duration (min.)	120	120	120	10~180

NOTE:

1) When the battery type is sealed, gel, flooded, the adjusting range of equalizing duration is 0 to 180min, and boost duration is 10 to 180min.

2) The following rules must be observed when modifying the value of the parameter in user battery type(factory default value is the same as sealed type):

- A. Over Voltage Disconnect Voltage > Charging Limit Voltage ≥ Equalize Charging Voltage ≥ Boost Charging Voltage ≥ Float Charging Voltage > Boost Reconnect Charging Voltage.
- B. Over Voltage Disconnect Voltage > Over Voltage Reconnect Voltage
- C. Low Voltage Reconnect Voltage > Low Voltage Disconnect Voltage ≥ Discharging Limit Voltage.
- D. Under Voltage Warning Reconnect Voltage > Under Voltage Warning Voltage ≥ Discharging Limit Voltage.
Boost Reconnect Charging voltage > Low Voltage Disconnect Voltage.

2)Lithium Battery Control Voltage Parameters

The parameters are in the 12V system at 25 °C; please double the values in the 24V system.

Battery type Voltage parameter	LiFePO ₄ (4S)	Li-NiCoMn (3S)	User
Over Voltage Disconnect Voltage	15.6V	13.5V	9~17V
Charging Limit Voltage	14.6V	12.6V	9~17V
Over Voltage Reconnect Voltage	14.5V	12.5V	9~17V
Equalize Charging Voltage	14.5V	12.5V	9~17V
Boost Charging Voltage	14.5V	12.5V	9~17V
Float Charging Voltage	13.8V	12.2V	9~17V
Boost Reconnect Charging	13.2V	12.1V	9~17V

Voltage			
Low Voltage Reconnect Voltage	12.4V	10.5V	9~17V
Under Voltage Warning Reconnect Voltage	12.5V	11.0V	9~17V
Under Volt. Warning Voltage	12.0V	10.5V	9~17V
Low Volt. Disconnect Voltage	11.0V	9.3V	9~17V
Discharging Limit Voltage	10.8V	9.3V	9~17V

The following rules must be observed when modifying the parameter values in User for the lithium battery.

- A. Over Voltage Disconnect Voltage > Over charging protection voltage (Protection Circuit Modules (BMS)) + 0.2V[※];
- B. Over Voltage Disconnect Voltage > Over Voltage Reconnect Voltage = Charging Limit Voltage ≥ Equalize Charging Voltage = Boost Charging Voltage ≥ Float Charging Voltage > Boost Reconnect Charging Voltage;
- C. Low Voltage Reconnect Voltage > Low Voltage Disconnect Voltage ≥ Discharging Limit Voltage;
- D. Under Voltage Warning Reconnect Voltage > Under Voltage Warning Voltage ≥ Discharging Limit Voltage;
- E. Boost Reconnect Charging voltage > Low Voltage Reconnect Voltage;
- F. Low Voltage Disconnect Voltage ≥ Over-discharging protection voltage (BMS) + 0.2V.











WARNING: The voltage parameters of the lithium battery can be set, but you must refer to the voltage parameters of lithium battery BMS.



WARNING: The required accuracy of BMS shall be at least 0.2V. If the deviation is higher than 0.2V, the manufacturer will assume no liability for any system malfunction caused by this.

6.6 Fault indication

Fault	Fault indicator	Charge indicator	LCD	Instruction
BATT2 overvoltage	Red Fast flashing	—	 	Battery level shows full, battery frame blink, fault icon blink.
BATT2 over-discharged	—	—	 	Battery level shows empty, battery frame blink, fault icon blink.
BATT2 over temperature	Red Fast flashing	—	 	Battery level shows current capacity, battery frame blink, fault icon blink, the temperature icon blink.
BATT2 system voltage error ^①	Red Fast flashing	Green Fast flashing	 	Battery level shows empty, battery frame blink.

① No alarm for limited voltage fault when using Lithium batteries.

7. Technical Specifications

Model	MT11
Apply to model	DRN series
Self-consumption(Power on)	13mA/5Vdc
Self-consumption(Power off)	4mA
Communication way	RS485
Communication port	3.81-4P
RS485 cable	CC-RS485-RS485-3.81-4P-150(1.5m) CC-RS485-RS485-3.81-4P-500(5m) CC-RS485-RS485-3.81-4P-1000(10m)
Environment temperature	-20℃ ~ +70℃
Storage temperature range	-20℃ ~ +70℃
Enclosure	IP20
Dimension	98.4x98.4mm
Base cover dimension	114x114mm
Weight	0.11kg

Any changes without prior notice!

Version number:1.1



BEIJING EPSOLAR TECHNOLOGY CO., LTD.

Tel: +86-10-82894896 / 82894112

Fax: +86-10-82894882

E-mail: info@epsolarpv.com

Website: www.epever.com