

UNI-T®

UT8803

Benchtop Digital Multimeter User Manual

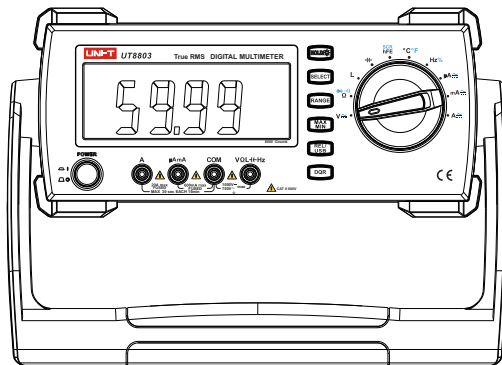

⚠ Warning: When the measured voltage is greater than 600V, The instrument cannot be used for measurements in CAT II, CAT III and CAT IV environment

I. Introduction

UT8803 is a professional 6000 count benchtop multimeter with high accuracy and outstanding performance. It supports multiple measurements:

- AC/DC voltage
- AC/DC current
- Resistance
- Frequency
- Capacitance
- Inductance
- Audion (hFE)
- Diode(LED)
- Thyristor(SCR)
- Continuity

Please carefully read and comply with all warnings and cautions in this manual.

II. Open box inspection

Open the package box and take out the instrument. Please check whether the following items are deficient or damaged and contact your supplier immediately if they are.

- User Manual(DVD-R)-----1pc
- Test leads-----1pair
- Alligator clip test line-----1pair
- Power line-----1pc
- Software DVD-----1pc
- USB cable-----1pcs
- Warranty-----1pc

III. Safety instructions

Safety standards

This instrument strictly follows the EN 61010-1: 2010, EN 61326: 2013, RoHS, pollution grade II safety standard, CAT II 600V.

⚠ Unplug the power cord when the instrument is not in use.

⚠ Note: In the case that the instrument is not used in accordance with the operation instructions, the protection provided by the instrument may be weakened or lost.

CLEANING

Be sure meter is turned off and wipe with a clean ,dry lint-free cloth.

Do not use abrasive cleaners or solvents

Power cord

specification:

Name	Description	Rating	Approval NO.
CORD	H05VVVF 3X0.75mm ²	300/500V	116006
PLUG	XR-T002	16A 250~	40036455
CONNECTOR	XR-W002	10A 250~	40040244

- 1) Before using the instrument, please check if there is any item which is damaged or behaving abnormally. If any abnormal item is found (such as: test lead bared, housing case damaged, LCD broken, etc.), please stop using the instrument. It is strictly prohibited to use an instrument without shell cover. Otherwise, there is a danger of electric shock.
- 2) If test lead is damaged, replace with the same type or of the same specifications.
- 3) Do not touch bare wire, connectors, input terminal or circuit being measured.
- 4) Use caution to measure voltage >DC 60V or AC 36Vrms, keep fingers behind finger guard to prevent shock hazard.
Before each use, verify operation by testing a known working circuit that is within the rating of this unit.
- 5) When measuring unknown voltage, switch the dial to the maximum range position.
- 6) Do not impose voltage or current exceeding the specified ones on the instrument.
- 7) Functional dial should be switched to proper position. After each measure, disconnect the test leads with the circuit. Pull out the power line if not use for long time. Do not switch the functional dial during measurement.

- 8) Do not use or store the instrument in high temperature, high humidity, flammable, explosive or strong magnetic field environments.
- 9) Do not change the internal circuit of the instrument in order to avoid the damage to the instrument and users.
- 10) Switch off the power supply after measurement

IV. General specifications

- 1) Max voltage between input terminal and COM jack: 1000V DC/750V AC
- 2) Fuse Type:
 - 10A Jack: (CE) F1 (12A H 1000V) Fuse ($\Phi 6.3 \times 32$) mm
 - mA/ μ A Jack: (CE) 600mA H 1000V Fuse ($\Phi 6.3 \times 32$) mm
- 3) Display: Max value: 5999; refresh 2~3 times/s
- 4) Range: Auto
- 5) Polarity: Auto
- 6) Overrange indicator: OL
- 7) Operating temperature: 0~40°C (32°F~104 °F)
- 8) Storage temperature: -10 °~50 °C (14 °F~122 °F)
- 9) Relative humidity: $\leq 75\%$ at 0 °C~30 °C; $\leq 50\%$ at 30 °C~40 °C
- 10) Electromagnetic compatibility:
 - RF=1V/m, overall accuracy=specified accuracy+5% of range.
 - RF>1V/m, no specified calculation.
- 11) Power Supply: AC 100V/120V/127V/220V/230VAC/240V, 450-440Hz, 28VA max Protection fuse being used: For AC 100V/120V/127V, AC 250V T 250mA For AC 220V/230V/240V, AC 250V T 125mA μ A mA FUSE: 400mA/1000V
- 12) Dimension: 320mm*265mm*110mm
- 13) Weight: 3100g (accessories excluded)
14. Safety standards: IEC 61010: CAT II 600V
15. CAT II: It is applicable to test and measuring circuits connected directly to utilization points (socket outlets and similar points) of the low-voltage MAINS installation.
- 16) Temperature coefficient: 0.1*(specified accuracy)/°C (<18 °C or ≥ 28 °C)

V.Display screen



1	C	Capacitance	11	hFE	Audion magnification
2	AUTO	Auto range	12		Diode& thyristor polarity
3	RANGE	Manual range	13		Thyristor/continuity/
4	MAX	Maximum value	14	Reading	
5	MIN	Minimum value	15	Unit	
6	HOLD	Data hold	16		Stimulation bargraph
7	RELΔ	Relative value	17		High voltage
8	SER	Series	18	L	Inductance
9	PAL	Parallel	19	D Q R	Capacitance loss factor, inductance quality factor, equivalent resistance measurement.
10	USB	USB connection			

20.	—	Negative value
21.	AC	Alternative current
22.	DC	Direct current

15.Measurement units:







mV、V	Voltage
μA、mA、A	Current
Ω、kΩ、MΩ	Resistance
nF、μF、mF	Capacitance
μH、mH、H	Inductance
Hz、kHz、MHz	Frequency
β	Thyristor magnification
°C/°F	Temperature

VI. Functions

Position	Input terminal	Functions (measurement modes)
V\dashv	V \longleftrightarrow COM	DC voltage
V\sim	V \leftrightarrow COM	AC voltage
Ω	V \leftrightarrow COM	Resistance
$\bullet\text{---})$	V \leftrightarrow COM	Continuity
Hz %	V \leftrightarrow COM	Frequency/ duty ratio
C	V \leftrightarrow COM	Capacitance
L	V \leftrightarrow COM	Inductance
D	V \leftrightarrow COM	Capacitance loss factor
Q	V \leftrightarrow COM	Inductance quality factor
R	V \leftrightarrow COM	Equivalent resistance
$\mu\text{A mA } \dashv$	$\mu\text{A mA } \longleftrightarrow$ COM	DC current
A\dashv	A \leftrightarrow COM	DC current
$\mu\text{A mA } \sim$	$\mu\text{A mA } \longleftrightarrow$ COM	AC current
A\sim	A \leftrightarrow COM	AC current
$\blacktriangleright\text{+}$	V-COM Multifunction socket (UTS-03A)	Diode(LED)
hFE	Multifunction socket (UTS-03A)	Audion magnification
SCR	Multifunction socket (UTS-03A)	Thyristor measurement
$^{\circ}\text{C}/^{\circ}\text{F}$	Multifunction socket (UTS-03A)	Temperature

VII. Structure







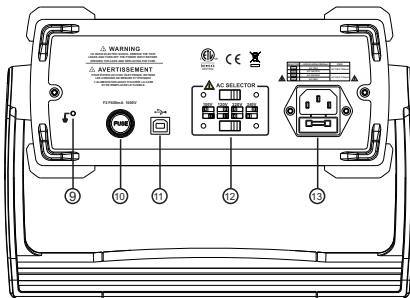
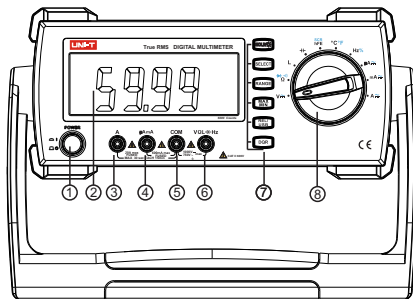



1. Power switch
2. Display screen
3. 20A jack
4. $\mu\text{A}/\text{mA}$ jack
5. COM jack
6. Function jack(voltage, resistance, inductance, capacitance, frequency, continuity, diode, duty ratio)
7. Buttons:

-  Data hold/backlight
-  Function switch
-  Range switch
-  Max/min value
-  Relative value/USB connection
-  Loss factor/ quality factor/ equivalent resistance

8. Function dial
9. Grounding
10. Fuse dial (F2 600mA)
11. USB port
12. AC voltage switch
13. Socket



Symbols on meter

	Power on
	Power off
	Direct current
	Alternating current
	Ground Terminal
	Caution, possibility of electric shock
	Warning or caution, To ensure safe operation and service of this meter, follow all warnings and instructions detailed in this manual.
	USB port
	Do not place equipment and its accessories in the trash. Items must be properly disposed of in accordance with local regulations.
	Comply with European Union Directive
	Conforms to UL STD. 61010-1, 61010-030, Certified to CSA STD. C22.2 No. 61010-1, 61010-030.
CAT II	It is applicable to test and measuring circuits connected directly to utilization points (socket outlets and similar points) of the low-voltage MAINS installation.

VIII. Operation instructions

Note: Select the corresponding input terminal. Functional dial should be switched to proper position

1. DC voltage measurement

- Insert red test lead to V jack, black lead to COM jack.
- Switch the dial to V_{DC} position, press **SELECT** button to enter DC measurement mode (figure 1). Connect the test leads to the load in parallel.
- Reading displayed.
- Press **RANGE** button to manually switch the range. Press **RANGE** 4 times to enter mV range.

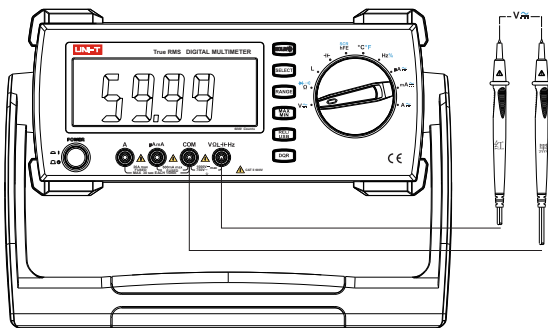

⚠ Note:

- Do not input voltage over 1000V, or it may pose shock hazard.
- Use caution to measure high voltage
- After each measurement, disconnect test leads and circuit being measured.

2.AC voltage measurement

- Insert red test lead to V jack, black lead to COM jack.
- Switch the dial to **V_{AC}** position, press **SELECT** button to enter AC measurement mode (figure 1). Connect the test leads to the load in parallel.
- Reading displayed. (Sine wave true RMS)
- Press **RANGE** button to manually switch the range. Press **RANGE** 4 times to enter mV range.

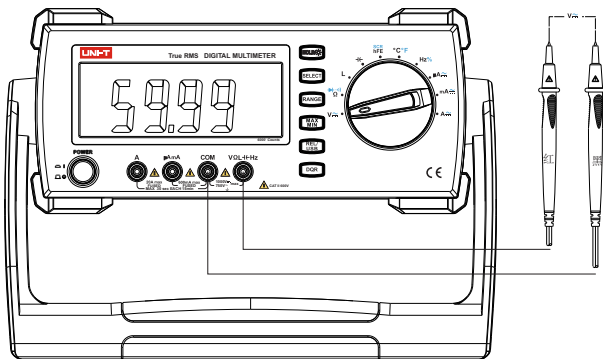

⚠ Note:

- Do not input voltage over 750V, or it may pose shock hazard.
- Use caution to measure high voltage
- After each measurement, disconnect test leads and circuit being measured.

3. Resistance measurement

- Insert red test lead to Ω jack, black lead to COM jack.
- Switch the dial to Ω position, press **SELECT** button to enter resistance measurement mode (figure 2).
Connect the test leads to the load in parallel.
- Reading displayed.
- Press **SELECT** button to manually switch the range.

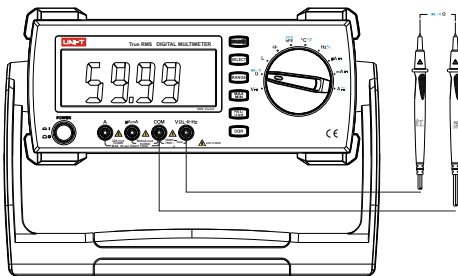

⚠ Note:

- If the resistor is open or over the range, the “OL” symbol will be displayed on the screen.
- Before measuring resistance, switch off the power supply of the circuit, and fully discharge all capacitors.
- When measuring low resistance, the test leads will produce 0.1 Ω –0.2 Ω measurement error. To obtain accurate measurement, short the test leads and use REL function.
- If the resistance when shorted is more than 0.5 Ω , please check if test leads are loosened or damaged.
- When measuring high resistance above 1M Ω , it is normal to take a few seconds to steady the readings. For steady readings, short test line can be used for measure.
- Do not input voltage over 30V (sine wave RMS), (peak value 42V) or DC 60V.
- After each measurement, disconnect test leads and circuit being measured.

4. Diode measurement

Method 1:

- Insert red test lead to \rightarrow jack, black lead to COM jack.
- Switch the dial to \rightarrow position, press **SELECT** button to enter diode measurement mode (figure 2). Connect the test leads to the load in parallel.
 - When \leftarrow appears, positive pole: red test lead; negative pole: black test lead
 - When \rightarrow appears, pole: black test lead; negative pole: red test lead
- Display reading of positive onset voltage of PN junction.

Method 2:

- Insert UT-S03A (multi-function socket) to the corresponding socket.(figure3)
- Insert the diode or LED pin to the socket marked with DIODE
 - When \leftarrow appears, positive pole: right side of socket; negative pole: left side of socket
 - When \rightarrow appears, positive pole: left side of socket; negative pole: right side of socket
- Display reading of positive onset voltage of PN junction.

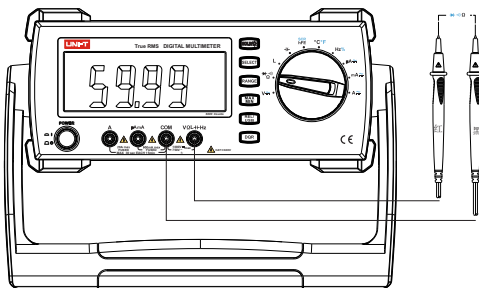

5. Continuity measurement



- Insert red test lead to Ω jack, black to COM jack.
- Switch the dial to Ω position, press HOLD to enter continuity measurement. Connect the test leads to the resistor in parallel. If circuit is well conducting, resistance $< 10\Omega$, buzzer goes off continuously; if circuit is open, resistance $> 50\Omega$, buzzer does not go off.
- Reading is displayed.

⚠ Note:

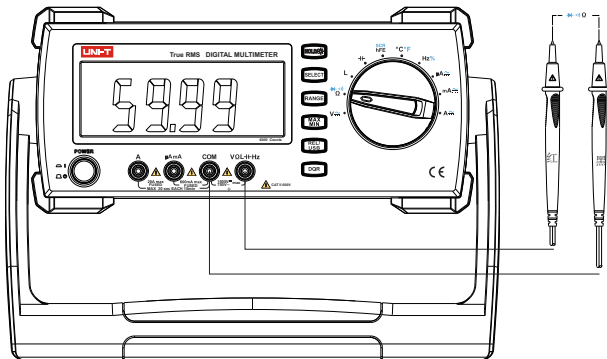
- Before measurement, please switch off all power supply and fully discharge all capacitors.
- Do not input voltage over 30V (sine wave RMS), (peak value 42V) or DC 60V.
- Disconnect test leads with the circuit after measurement.



6. Inductance measurement

- Insert red test lead to L jack, black test lead to COM jack.
- Switch the dial to L position, connect test leads with the inductance in parallel.
- Reading is displayed.
- Press  to manually switch the range.
- Press  to switch Q/R functions, long press this button to return to inductance measurement.

⚠ Note:



- Before measurement, please switch off all power supply and fully discharge all capacitors.
- For accuracy, please reset the reading to 0 before measurement.

⚠ Method:

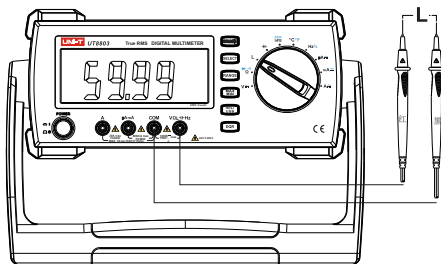
- When the test leads in open status and frequency is 1kHz, press REL to reset the reading to zero.
 - When the test leads are shorted and frequency is 10kHz, press REL to reset the reading to zero.
- For inductance over 1H, it takes long time to steady the reading
 - Values of capacitance loss factor (D) and inductance quality factor (Q) are only for reference.
 - Do not input voltage over 30V (sine wave RMS), (peak value 42V) or DC 60V.
 - Disconnect test leads with the circuit after measurement.



7.Capacitance measurement

- Insert red test lead to C jack, black test lead to COM jack.
- Switch the dial to ** position, connect test leads with capacitor in parallel.
- Reading is displayed,
- Press  to manually switch the range.
- Press  to switch Q/R functions, long press this button to return to capacitance measurement.

⚠ Note:

- If the circuit being measurement is shorted or the capacitance is over range, OL will appear.
- There may be dozens of remaining digits because of the intrinsic capacitors. Please reset the reading to 0 before measurement.

⚠ Method:

- When the test leads in open status and frequency is 1kHz, press REL to reset the reading to zero.
 - When the test leads are shorted and frequency is 100Hz, press REL to reset the reading to zero.
- For capacitor over 600 μ F, it takes long time to obtain reading.
 - Before measurement, please switch off all power supply and fully discharge all capacitors. Pay particular attention to capacitors with high voltage.
 - Do not input voltage over 30V (sine wave RMS), (peak value 42V) or DC 60V.
 - Disconnect test leads with the circuit after measurement.

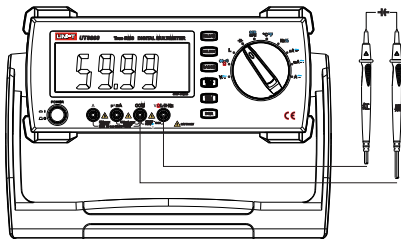

9. Thyristor measurement

- Insert UT-S03A (multi-function socket) to the instrument.
- Switch the dial to $\overset{\text{SCR}}{\text{HFE}}$ position, press HOLD to switch to thyristor measurement.
- Insert SCR correctly to UT-S03A: G(gate), A(anode), K(cathode)
- Display as following:

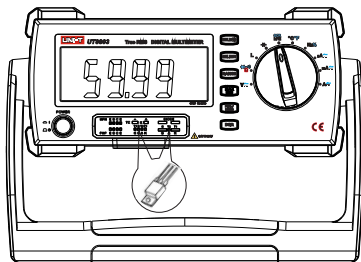

LCD display	SCR polarity symbol	Status	SCR polarity
0.1V~2V	$\odot \rightleftarrows \odot$	Normal	Two-way
0.1V~2V	$\blacktriangleright +$	Normal	One-way
ERR	— — —	Bad contact	Unknown
OL	— — —	Not connected/bad contact	Unknown

⚠ Note:

- Before measurement, please switch off all power supply and fully discharge all capacitors. Pay particular attention to capacitors with high voltage.
- Do not input voltage over 30V (sine wave RMS), (peak value 42V) or DC 60V.
- Disconnect test leads with the circuit after measurement.

10. Temperature measurement

- Insert UT-S03A(multi-function socket) to the instrument.
- Switch the dial to °C°F position, press  button to switch temperature unit. OL appears if no thermocouple connected.
- Insert the thermocouple to UT-S03A, pay attention to the polarity. (reverse polarity results in negative reading.)

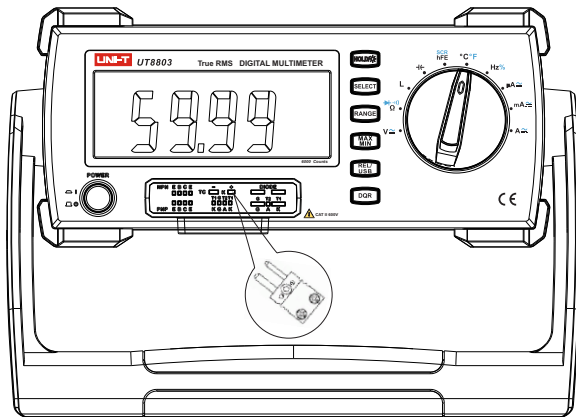

11. Frequency measurement.

- Insert red test lead to Hz% jack, black to COM jack.
- Switch the dial to Hz% position, press **SELECT** to frequency measurement.
- Connect the test leads with frequency source in parallel.
- Reading is displayed.

⚠ Note:

- Do not input over 30V AC or it will pose shock hazard.
- Disconnect test leads with the circuit after measurement.

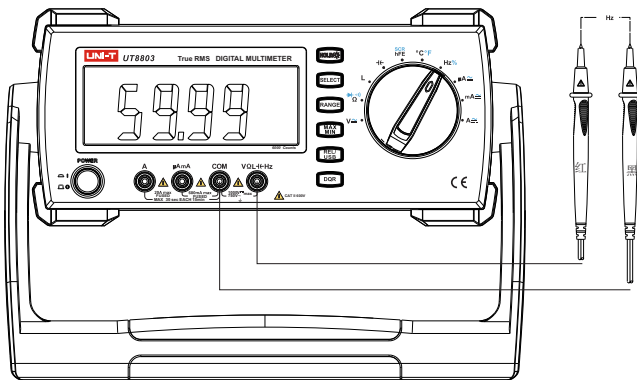

12. Duty ratio measurement

- Insert red test lead to Hz% jack, black to COM jack.
- Switch the dial to Hz% position, press **FUNC** to enter duty ratio measurement.
- Connect the test leads with signal source in parallel.
- Reading is displayed.

▲ Note:

- Do not input over 36V AC or it will pose shock hazard.
- Disconnect test leads with the circuit after measurement.
- Duty ratio measurement function of UT8803 is only for reference.

13. Current measurement

- Insert red test lead to μA mA or A jack, black to COM jack.
- Switch the dial to μA mA A position, press **FUNC** to enter AC/DC measurement.
- Connect the test leads with signal source in series.
- Reading is displayed. When measuring AC current, reading is sine wave RMS.

▲ Note:

- Before measurement, switch off the power supply of the circuit to be measured, fully discharge all high voltage capacitors.
- If the current is unknown, select the maximum range and reduce it accordingly.
- Do not connect the test leads with circuit in parallel.
- Disconnect test leads with the circuit after measurement.
- When measuring current $> 20\text{A}$, measurement time should be less than 30s with over 15 mins interval or it may pose shock hazard or injury to human.

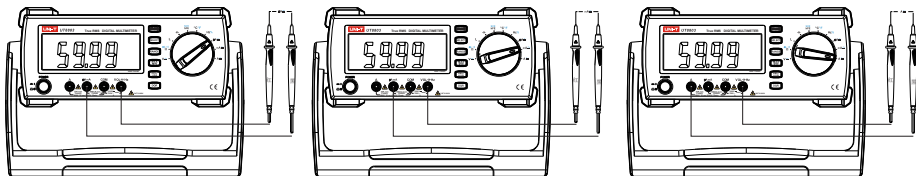

IX. Technical specifications

Accuracy: \pm (% of reading + least significant digit), 1 year warranty

Ambient temperature: 18°C~28°C

Ambient humidity: \leq 75% RH

1.DC voltage

Range	Resolution	Accuracy
6000mV	0.1mV	\pm (0.5%+2)
6V	1mV	\pm (0.3%+2)
60V	10mV	
600V	100mV	
1000V	1V	\pm (0.5%+3)

- Input impedance: 10M Ω ; Maximum voltage:1000V

2.AC voltage

Range	Resolution	Accuracy
600mV	0.1mV	40Hz-1kHz:±(0.6%+5)
		≥ 1kHz-10kHz:±(1.2%+5)
		≥ 10kHz-20kHz:±(3%+5)
		≥ 20kHz-100kHz:±(4%+5)
6V	1mV	40Hz-1kHz:±(0.6%+5)
		≥ 1-10kHz: ±(1.2%+5)
		≥ 10-20kHz: ±(3%+5)
		≥ 20-100kHz: ±(4%+5)
60V	10mV	40Hz-1kHz: ±(0.6%+5)
		≥ 1-10kHz: ±(1.5%+5)
		≥ 10-20kHz: ±(3%+5)
		≥ 20-100kHz: ±(8%+5)
600V	100mV	40 Hz-1kHz: ±(0.6%+5)
		≥ 1-10kHz: ±(3.5%+5)
750V	1V	40Hz-1kHz: ±(1.2%+5)
		≥ 1-3kHz: ±(3%+5)

- Input impedance: 10MΩ; Maximum voltage:750Vrms.
- Frequency response: 40Hz~100kHz.
- Display: Sine wave true RMS (average response)
- In open status, there is residual reading which do not affect accuracy.

3.DC current

Range	Resolution	Accuracy
600 μ A	0.1 μ A	$\pm (0.8\%+3)$
6mA	1 μ A	
60mA	10 μ A	
600mA	100 μ A	$\pm(1.5\%+3)$
20A	10mA	$\pm(2\%+5)$

- If current $\geq 10A$, measure time should be less than 30s with 15mins interval. In open status, allowable error: ≤ 5 residual digits.

4.AC current

Range	Resolution	Accuracy
600 μ A-6mA	0.1-10 μ A	40Hz-10kHz $\pm(1\%+5)$
		>10-15kHz: $\pm(2\%+5)$
60mA-600mA	100 μ A	40Hz-5kHz: $\pm(1\%+5)$
		>5kHz-15kHz: $\pm(3\%+5)$
20A	10mA	40Hz-1kHz: $\pm(2.0\%+6)$
		>1k-15kHz; $\pm(3.0\%+6)$

- Frequency response: 40Hz~15kHz.
- If current $\geq 10A$, measure time should be less than 30s with 15mins interval. In open status, allowable error: ≤ 5 residual digits.

5. Resistance

Range	Resolution	Accuracy
600Ω	0.1Ω	± (0.8%+5)
6kΩ	1Ω	± (1%+5)
60kΩ	10Ω	
600kΩ	100Ω	
6MΩ	1kΩ	± (2%+5)
60MΩ	10kΩ	± (5%+5)

- Open circuit voltage: -1.2V

6.Capacitance

Range	Resolution	Accuracy
6nF	1PF	± (2.5%+5)
60nF	10PF	± (1.5%+5)
600nF	100pF	
6μF	1nF	± (3%+10)
60μF	1nF	
600μF	10nF	± (5%+5)
6mF	100μF	± (10%+8)

- Minimum measure range: >8PF;
- If capacitance >6.6mF, OL symbol appears
- Input impedance: 4kΩ

7. Inductance

Range	Resolution	Accuracy
600 μ H	0.1 μ H	\pm (2.5%+5)
6mH	1 μ H	\pm (2%+5)
60mH	10 μ H	
600mH	100 μ H	
6H	1mH	
60H	10mH	
100H	100mH	Only for reference

- Measure voltage: 0.6V RMS
- Minimum measure range: >16 μ H
- Input impedance: 4K Ω

8. Equivalent resistance (ACR) Ω

Range	Resolution	Accuracy
60 Ω	0.01 Ω	\pm (2%+10)
600 Ω	0.1 Ω	\pm (1%+5)
6k Ω	1 Ω	
60k Ω	10 Ω	
600k Ω	100 Ω	
6M Ω	1k Ω	\pm (5%+5)



- Minimum measure range: >0.1 Ω
- Input impedance: 4K Ω

9. Frequency/ duty ratio



Range	Resolution	Accuracy
600Hz	0.1Hz	± (0.1%+10)
6kHz	1Hz	
60kHz	10Hz	
600kHz	100Hz	
6MHz	1kHz	
20MHz	10kHz	
5%~95%	0.10%	Only for reference

- Sensitivity: frequency<600KHz, amplitude>1.5Vrms or frequency>600kHz, amplitude>2.5Vrms, minimum input>5Hz.
- Duty ratio measurement only applicable for square wave ≤10kHz.
2Vpp≤input amplitude≤30Vpp
Frequency≤1kHz, Duty: 5.0%~95.0%
Frequency>1kHz, Duty: 30.0%~70.0%

10. Diode/ audion/ thyristor/ continuity

Function	Position	Resolution	Accuracy
Diode		10mV	0.5~0.8V
SCR test	SCR	10mV	0.1~2V
Audion hFE	hFE	1β	No specified
Continuity		About 0.1Ω	No specified

- When measuring hFE, Ib0: about 10μA; Vce: about 2.8V
- When measuring diode, Silicon PN junction onset voltage drop: 0.5~0.8V, open status voltage: 8V
- When measuring continuity, in good conducted circuit, resistance <10Ω, buzzer goes off; in open circuit, resistance>30Ω, buzzer does not go off.
- When measuring SCR, onset voltage drop: 0.1~2V; open circuit voltage: about 9V.

Display	SCR polarity indicator	Status	SCR polarity
0.1V~2V		Normal	Two-way
0.1V~2V		Normal	One-way
ERR	---	SCR bad contact	Unknown
OL	---	SCR not connected or bad contact	Unknown

11. Temperature





Range	Resolution	Accuracy
-40°C~0°C	1°C	±2%+5°C
>0°C~400°C		±1%+5°C
>400°C~1000°C		±2%+3°C
-40°F~32°F	1°F	±2%+9°F
>32°F~752°F		±1%+9°F
>752°F~1832°F		±2%+6°F

- K-type thermocouple applicable

X. Power supply and fuse replacement

1. Power supply setting

- 1) Turn the red switch to the corresponding position
- 2) Setting steps:
 - a. Unplug the power cord
 - b. Turn the red switch to corresponding position
 - c. Selectable positions are shown below

Position	Voltage	Demonstration	Description
1	100V		Input corresponding voltage
2	120V/127V		
3	220V/230V		
4	240V		

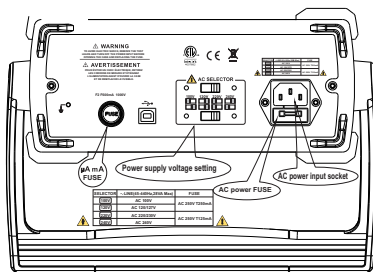

2. Fuse replacement

- 1) Unplug the test leads from the instrument.
- 2) Turn off the power supply for the instrument
- 3) Open the fuse housing with a screwdriver.
- 4) Replaced the fuse with new one.

UNI-T®

UNI-TREND TECHNOLOGY (CHINA) LIMITED

Manufacturer:

No6, Gong Ye Bei 1st Road,
Songshan Lake National High-Tech Industrial
Development Zone, Dongguan City,
Guangdong Province, China

Tel: (86-769) 8572 3888

Fax: (86-769) 8572 5888

Postal Code: 523 808

<http://www.uni-trend.com>

Headquarters:

Rm 901,9/F,Nanyang Plaza,57 Hung To Road,
Kwun Tong, Kowloon,Hong Kong