



# Installation Guide

DeltaStream GPON Optical Line Terminal

# About this Installation Guide

This Installation Guide describes the hardware characteristics, installation methods and the points that should be attended to during the installation. This Installation Guide is structured as follows:

## Chapter 1 Introduction

This chapter describes the external components of the device.

## Chapter 2 Installation

This chapter illustrates how to install the device.

## Chapter 3 Connection

This chapter illustrates how to do the physical connection of the device.

## Chapter 4 Configuration

This chapter illustrates how to configure the device.

## Appendix A Troubleshooting

## Appendix B Hardware Specifications

# Audience



This Installation Guide is for:

Network Engineer

Network Administrator

# Conventions

- Some models featured in this guide may be unavailable in your country or region. For local sales information, visit <https://www.tp-link.com>.
- The figures in this guide are for demonstration purposes only. Your device may differ in appearance from that depicted.
- This guide uses the specific formats to highlight special messages. The following table lists the notice icons that are used throughout this guide.

	Remind to be careful. A caution indicates a potential which may result in device damage.
	Remind to take notice. The note contains the helpful information for a better use of the product.

# Related Document

The related documents of the product are provided on Download Center. To obtain the latest product information, visit the official website: <https://www.tp-link.com>.

# Contents

---

Chapter 1	Introduction	2
1.1	Product Overview	2
1.2	Appearance	3
Chapter 2	Installation	6
2.1	Package Contents	6
2.2	Safety Precautions	6
2.3	Installation Tools	8
2.4	Product Installation	8
Chapter 3	Connection	10
3.1	Port Connection	10
3.2	Verify Installation	11
3.3	Power On	11
3.4	Initialization	13
Chapter 4	Configuration	14
4.1	Via the MGMT Port	14
4.2	Via the SFP+/GE Port	14
4.3	Via the Console Port	15
Appendix A	Troubleshooting	16
Appendix B	Specifications	17

# Chapter 1 Introduction

## 1.1 Product Overview

TP-Link GPON OLT (Optical Line Terminal) products are designed to provide business-class solutions for ISP's access networks, and they are scalable and reliable for deploying services to meet various demands of ISP's customers.

A simplified network topology is shown as the following figure. We take DS-P7001-08 as an example of OLT devices.

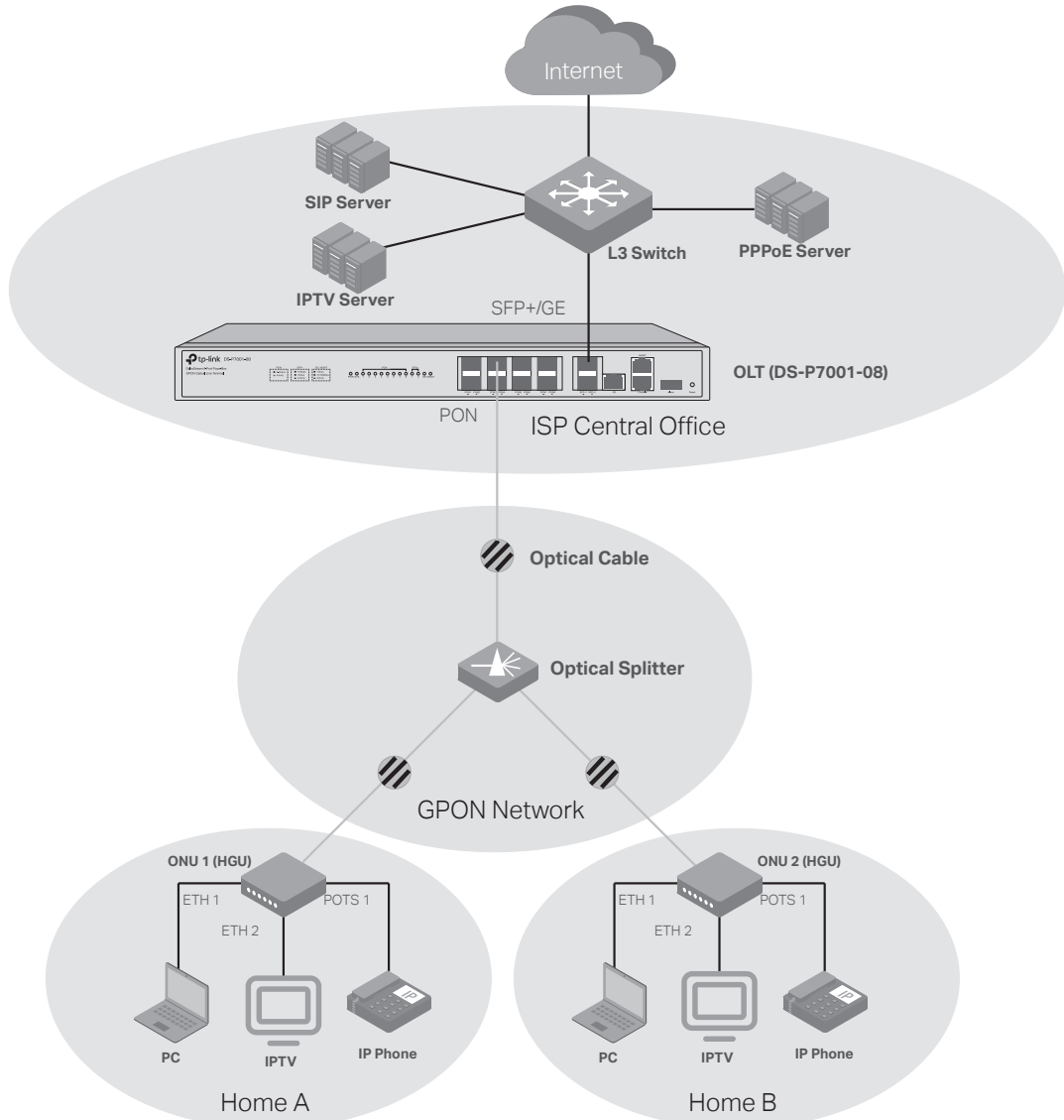

## 1.2 Appearance

### Front Panel

The front panel of DS-P7001-08 is shown as the following figure. The figure is for demonstration purposes only. Your device may differ in appearance from the depicted.

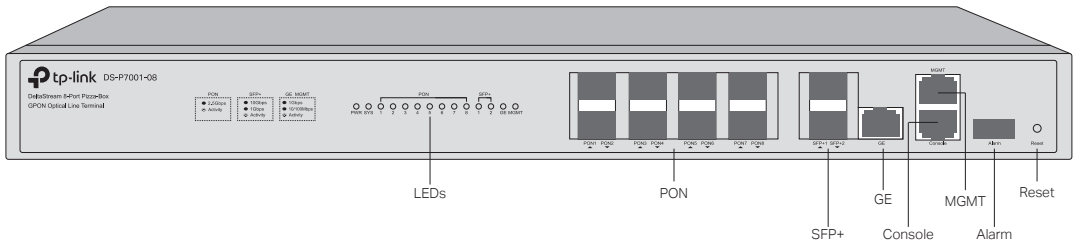

The front panel of DS-P7001-04 is shown as the following figure. The figure is for demonstration purposes only. Your device may differ in appearance from the depicted.

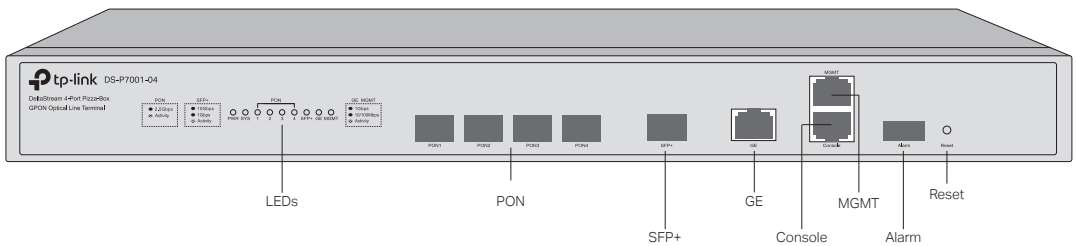

### PON

The PON port connects to the GPON network via an OLT SFP module and an optical cable. GPON networks are extended from the PON ports of OLT, and oriented to the locations of ISP's end users.

### SFP+

The SFP+ port connects to the uplink network of ISP's central office via an 10 Gbps SFP+ module and an optical cable.

### GE

The GE port connects to the uplink network of ISP's central office via an Ethernet cable.

### MGMT

The MGMT port connects to a management terminal like a PC via an Ethernet cable, and then the network manager can configure and monitor the device via the management webpage.

### Console

The Console port connects to a management terminal like a PC via an RJ45 console cable, and then the network manager can configure and monitor the device via the CLI (Command Line Interface).

### Alarm

The Alarm port connects to a monitoring device, sending alarm messages.

### Reset

If you want to reset the the device, press and hold the reset button for more than 5 seconds.

## LEDs

LED	Indication
PWR	<p><b>On:</b> The device is powered on.</p> <p><b>Off:</b> The device is powered off or power supply is abnormal.</p> <p><b>Flashing:</b> Power supply is abnormal.</p>
SYS	<p><b>On:</b> The device works properly.</p> <p><b>Off:</b> The device works improperly.</p> <p><b>Flashing Slowly and Then Quickly:</b> The reset button is pressed and held and then the device is reset to the default settings.</p> <p><b>Flashing Normally:</b> The device is upgrading.</p> <p><b>Flashing Quickly:</b> There are alarms.</p>
PON	<p><b>Green On:</b> Running at 2.5 Gbps, but no activity.</p> <p><b>Green Flashing:</b> Running at 2.5 Gbps and transmitting or receiving data.</p> <p><b>Off:</b> No device is linked to the corresponding port.</p>
SFP+	<p><b>Green On:</b> Running at 10 Gbps, but no activity.</p> <p><b>Green Flashing:</b> Running at 10 Gbps and transmitting or receiving data.</p> <p><b>Yellow On:</b> Running at 1 Gbps, but no activity.</p> <p><b>Yellow Flashing:</b> Running at 1 Gbps and transmitting or receiving data.</p> <p><b>Off:</b> No device is linked to the corresponding port.</p>
GE / MGMT	<p><b>Green On:</b> Running at 1 Gbps, but no activity.</p> <p><b>Green Flashing:</b> Running at 1 Gbps and transmitting or receiving data.</p> <p><b>Yellow On:</b> Running at 10/100 Mbps, but no activity.</p> <p><b>Yellow Flashing:</b> Running at 10/100 Mbps and transmitting or receiving data.</p> <p><b>Off:</b> No device is linked to the corresponding port.</p>

### ■ Rear Panel

The rear panel of DS-P7001-08 is shown as the following figure.

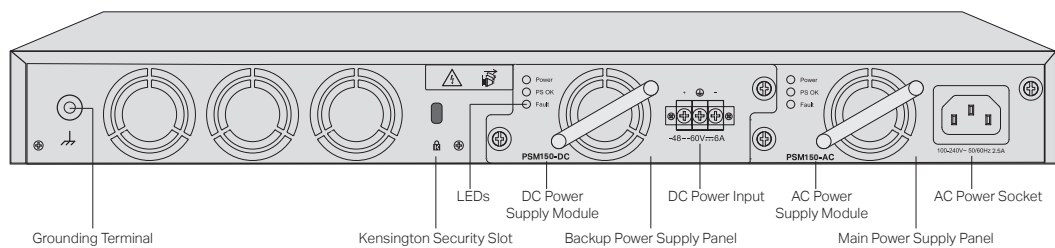

The rear panel of DS-P7001-04 is shown as the following figure.

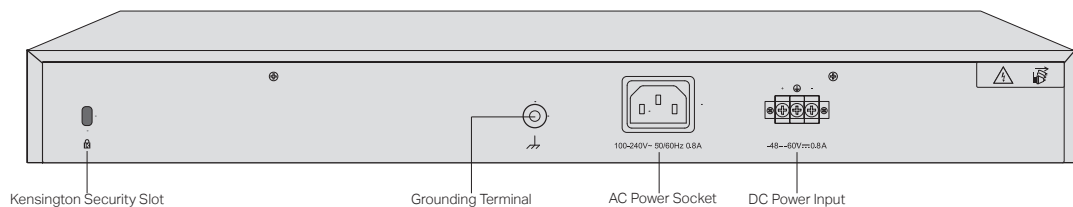

## Grounding Terminal

The device already comes with lightning protection mechanism. You can also ground the device through the PE (Protecting Earth) cable of AC cord or with Ground Cable. For detailed lightning protection measures, refer to the **Lightning Protection Guide** from the website: [https://www.tp-link.com/us/configuration-guides/lightning\\_protection\\_guide/](https://www.tp-link.com/us/configuration-guides/lightning_protection_guide/).

## Kensington Security Slot

Secure the lock (not provided) into the security slot to prevent the device from being stolen.

## AC Power Socket

Plug the negative connector of the power cord directly into the AC power socket and plug the positive connector into an AC power outlet. Make sure that the voltage of the power supply meets the requirement of the input (100-240V~ 50/60Hz).

## DC Power Input

Attach the power wires to the DC power input. We recommend you use 18-14 AWG wires. Connect the positive pole of the DC power supply to the "+" end, and the negative pole to the "-" end. Make sure the power supply meets the requirement of the input (48-60V). An all-pole mains switch in accordance with EN 62368-1 2014 Annex L shall be incorporated in the electrical installation of the building. And the disconnect device shall have a contact separation at least 1.5mm.

## Main Power Supply Panel / Backup Power Supply Panel (Only for Certain Devices)

There are multiple power supply panels on certain devices, where AC or DC power supply modules can be installed. The main power supply panel takes priority over the backup one. If the main one works normally, the backup one does not work. If the main one fails, the backup one starts to work.

## AC Power Supply Module / DC Power Supply Module (Only for Certain Devices)

There are detachable power supply modules on certain devices. If you want to detach the power supply module, you can hot swap it by unscrewing the module and pulling the handle. If needed, you can purchase additional power supply modules.



### Note:

For detailed information about power supply modules, refer to the Installation Guide of Power Supply Modules, which can be found on the Support page of the product at our website.

## LEDs (Only for Certain Devices)

LED	Indication
Power	<b>On:</b> The power supply module is powered on. <b>Off:</b> The power supply module is powered off or power supply is abnormal.
PS OK	<b>On:</b> The power supply module is supplying power normally. <b>Off:</b> The power supply module is not supplying power or power supply is abnormal.
Fault	<b>On:</b> There are some faults and the power supply module is working abnormally. <b>Off:</b> There are no faults and the power supply module is working normally.

## Chapter 2 Installation

### 2.1 Package Contents

Make sure that the package contains the following items. Please contact your distributor, if any of the listed items is damaged or missing. The figures are for demonstration only. The actual items may differ in appearance and quantity from the depicted.

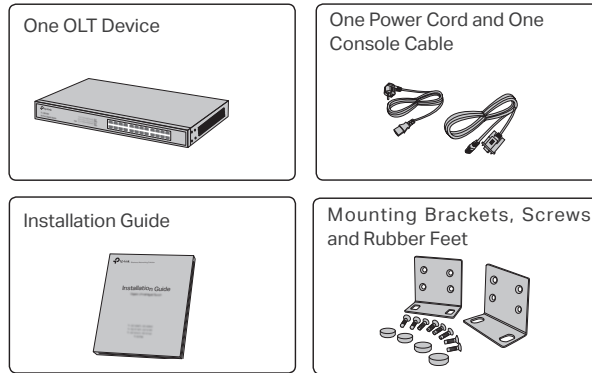

### 2.2 Safety Precautions

To avoid any device damage and bodily injury caused by improper use, you should observe the following rules.

- **Safety Precautions**
  - Keep the power off during the installation.
  - Wear an ESD-preventive wrist strap, and make sure that the wrist strap has a good skin contact and is well grounded.
  - Use only the power cord provided with the device.
  - Make sure that the supply voltage matches the specifications indicated on the rear panel of the device.
  - Ensure that the device is installed in a well-ventilated environment and its ventilation hole is not blocked.
  - Do not open or remove the cover of the device.
  - Before cleaning the device, cut off the power supply. Do not clean it by the waterish cloth, and never use any other liquid cleaning method.
  - Place the device with its bottom surface downward.

- **Site Requirements**

#### Temperature/Humidity





Keep the equipment room at an appropriate level of temperature and humidity. Too much or too little humidity may lead to bad insulation, leakage of electricity, mechanical property changes, and corrosion. High temperatures may accelerate aging of the insulation materials, significantly shortening the service life of the device. To find out the best temperature and humidity conditions for the device, check the Appendix B Specifications.

### Clearness



The dust accumulated on the device can be absorbed by static electricity and result in poor contact of metal contact points. Some measures have been taken for the device to prevent static electricity, but too strong static electricity can cause deadly damage to the electronic elements on the internal circuit board. To avoid the effect of static electricity on the operation of the device, attach much importance to the following items:

- Dust the device regularly, and keep the indoor air clean.
- Keep the device well grounded and ensure that the static electricity has been transferred.

### Electromagnetic Interference

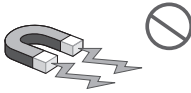

Electronic elements including capacitance and inductance on the device can be affected by external interferences, such as conducted emission by capacitance coupling, inductance coupling, and impedance coupling. To decrease the interferences, make sure to take the following measures:

- Use the power supply that can effectively filter interference from the power grid.
- Keep the device far from high-frequency and strong-current devices such as radio transmitting station.
- Use electromagnetic shielding when necessary.

### Lightning Protection



Extremely high voltage currents can be produced instantly when lightning occurs and the air in the electric discharge path can be instantly heated up to 20,000 °C. As this instant current is strong enough to damage electronic devices, more effective lightning protection measures should be taken.

- Ensure that the rack and the device are well earthed.
- Make sure the power socket has a good contact with the ground.

- Keep a reasonable cabling system and avoid induced lightning.
- Use the signal SPD (Surge Protective Device) when wiring outdoor.

**Note:**

For detailed lightning protection measures, refer to the **Lightning Protection Guide** from the website:  
[https://www.tp-link.com/us/configuration-guides/lightning\\_protection\\_guide/](https://www.tp-link.com/us/configuration-guides/lightning_protection_guide/).

## Installation Site

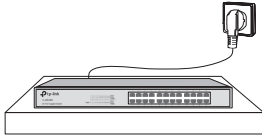

When installing the device on a rack or a flat workbench, attach much importance to the following items:

- The rack or workbench is flat, stable, and sturdy enough to support the weight of 5.5 kg at least.
- The rack or workbench has a good ventilation system. The equipment room is well ventilated.
- The rack is well grounded. Keep the device less than 1.5 meters away from the power socket.

## 2.3 Installation Tools

- Phillips screwdriver
- ESD-preventive wrist wrap
- Cables

**Note:**

These tools are not included with our product. If needed, you can purchase them separately.

## 2.4 Product Installation

To install the device in an EIA standard-sized, 19-inch rack, follow the instructions described below:

1. Check the efficiency of the grounding system and the stability of the rack.
2. Secure the supplied rack-mounting brackets to each side of the device with supplied screws, as illustrated in the following figure.

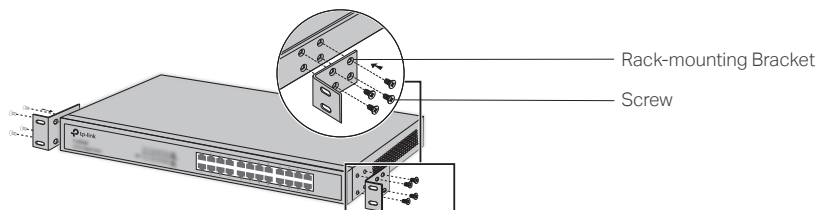

3. After the brackets are attached to the device, use suitable screws (not provided) to secure the brackets to the rack, as illustrated in the following figure.

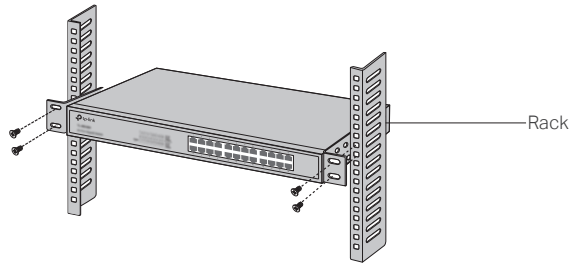
**Caution:**

- Leave 5 to 10 cm gaps around the devices for air circulation.
- Avoid placing heavy things on the device.
- Place the device with its bottom facing downwards.
- Mount devices in sequence from the bottom to top of the rack and ensure a certain clearance between devices for the purpose of heat dissipation.

## Chapter 3 Connection

### 3.1 Port Connection

Connect the ports of OLT to the devices and networks according to your needs. Some options for port connection are demonstrated in the following figure. We take DS-P7001-08 as an example of OLT devices.

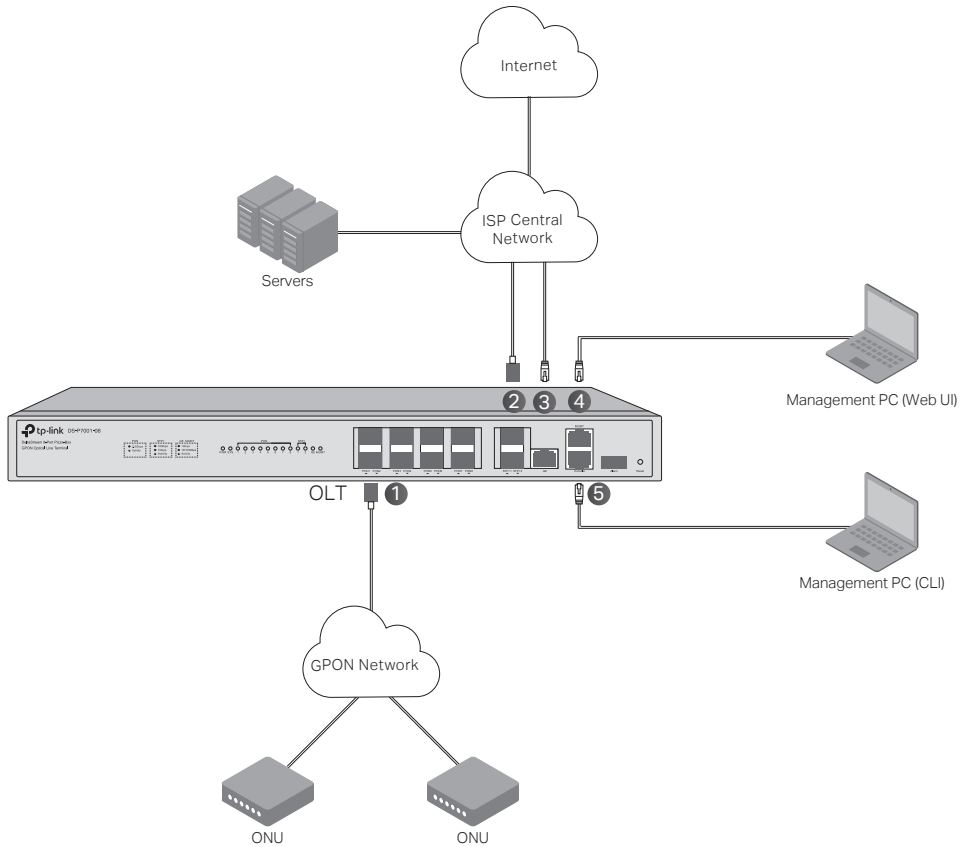

- ① Install the OLT SFP module to the PON port and connect it to the GPON network using an optical cable.
- ② Install the 10 Gbps SFP+ module to the SFP+ port and connect it to the ISP central network using an optical cable.
- ③ Connect the GE port to the ISP central network using an Ethernet cable.
- ④ Connect the MGMT port to the management PC using an Ethernet cable in order to configure and monitor the device via the web UI.
- ⑤ Connect the Console port to the management PC using an RJ45 console cable in order to configure and monitor the device via the CLI.

## 3.2 Verify Installation

---

After completing the installation, verify the following items:

- There should be 5 to 10 cm of clearance around the device for ventilation and make sure the air flow is adequate.
- The voltage of the power supply meets the requirement of the input voltage of the device.
- The power socket, device and rack are well grounded.
- The device is correctly connected to other network devices.

## 3.3 Power On

---



### Note:

- You can use either AC or DC power supply to power the device. However, it is recommended to use both AC and DC power supply simultaneously as backup for each other in case of power failure.
- For DS-P7001-08, there are three modes of dual power supplies, i.e. AC-DC, AC-AC, and DC-DC. If you use AC-DC, it's recommended that you install the DC power supply module on the backup panel and the AC power supply module on the main panel. It's recommended that you use a standard AC power outlet for main power supply, and a UPS (Uninterruptible Power Supply) for backup power supply in case of power failure.
- For DS-P7001-04, the AC power supply takes priority over the DC power supply. If the AC power supply works normally, the DC power supply does not work. If the AC power supply fails, the DC power supply starts to work.

### ■ Using AC Power Supply

Plug the female connector of the provided power cord into the power socket of the device, and the male connector into a power outlet with earthing connection. Make sure that the voltage of the power supply meets the requirement of the input (100-240V~ 50/60Hz). In the following figure, we take DS-P7001-08 as an example. Your device may differ in appearance from the depicted.

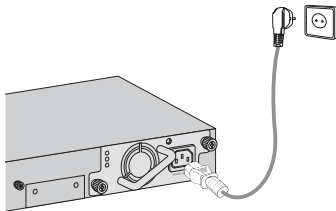

### Caution:

For AC power supply, please use the provided AC power cord.

### ■ Using DC Power Supply

In the following figures, we take DS-P7001-08 as an example. Your device may differ in appearance from the depicted.

#### 1. Connect the power cord

It is recommended to use an 18-14 AWG power cord to connect the power supply equipment and the DC power input of the device, and make sure that the connection is reliable. When connecting, make sure that the positive and negative poles of the power supply equipment correspond to the positive

and negative poles of the device, and that the power supply meets the requirement of the input. An all-pole mains switch in accordance with EN 62368-1 2014 Annex L shall be incorporated in the electrical installation of the building. And the disconnect device shall have a contact separation at least 1.5mm.

### 2. Connect to the ground

In different environments, the device may be grounded differently. The following will instruct you to connect the device to the ground in two ways. Note that the protective earthing terminal must be connected to the installation protective earthing conductor.

- Use the grounding bar

If the device is installed in the Equipment Room, where a grounding bar is available, it is recommended to connect the device to the grounding bar with an 18-14 AWG ground cable as shown in the following figure.

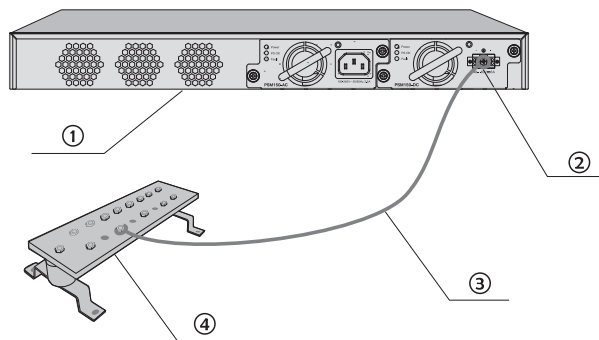

- |                            |                      |
|----------------------------|----------------------|
| ① Device (Rear Panel)      | ② Grounding Terminal |
| ③ Ground Cable (18-14 AWG) | ④ Grounding Bar      |

- Equipotential bonding

Equipotential bonding is the practice of intentionally electrically connecting all earthed systems to the same grounding grid or connecting the grounding grids of all the earthed systems together through the ground or overground metal so as to create an earthed equipotential zone. When lightning occurs, the high voltage produced by lightning current in all systems will meanwhile exist in their ground cables, and thus all ground cables have the same electrical potential and basically eliminate the electric strikes between the systems. The figure below illustrates how to practice equipotential bonding in a network.

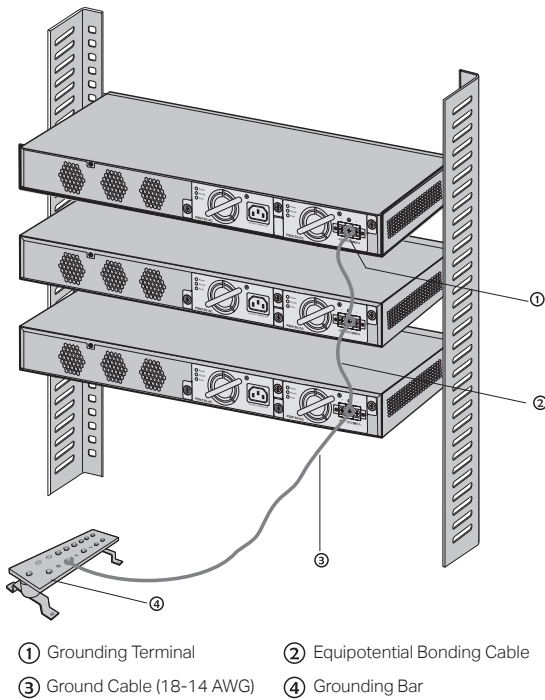

#### Caution:

- The product can be powered by a DC power source such as accumulator cell and a power supply server. The DC power supply should comply with EN 62368-1 2014 clause 5.4.2.3.2.3, and the transient voltage shall be no more than  $2500 V_{\text{peak}}$ .
- For DC power supply, please note that the power wires and disconnecting device are not included with our product. If needed, you can purchase them separately.
- For DC power supply, the rating of the external overcurrent protective device shall not exceed 16 A.

### 3.4 Initialization

After the device is powered on, it begins the Power-On Self-Test. A series of tests run automatically to ensure the device functions properly. During this time, its LED indicators will respond as follows:

1. The PWR LED keeps on all the time.
2. The SYS LED flashes momentarily and turns off. After the initial process succeeds, the SYS LED keeps on.
3. The port LEDs flash momentarily and turn off. Then the port LEDs start to indicate status of ports normally.

## Chapter 4 Configuration

The device supports three configuration options:

- Via the MGMT Port
- Via the SFP+/GE Port
- Via the Console Port



### Note:

For the detailed configurations, refer to the User Guide of the device. We take DS-P7001-08 as an example of OLT devices in the following figures.

### 4.1 Via the MGMT Port

1. Connect the MGMT port of OLT to the management PC using an Ethernet cable.

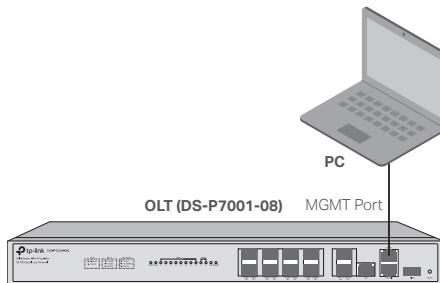

2. Set the IP address of the PC as **192.168.1.x/24** (x is a number between 2 and 254).

3. You can access the device using the Web UI or the CLI.

- **Using the Web UI:** Open the web browser on the PC. Enter **192.168.1.1** in the address bar to open the web UI of the device. Log in to the web UI. The default username and password are both **admin**. The first time you log in, you are required to change the password for security purposes.
- **Using the CLI:** Use a telnet or SSH terminal to access **192.168.1.1** to open the CLI of the device. Log in to the CLI. The default username and password are both **admin**. The first time you log in, you are required to change the password for security purposes.

### 4.2 Via the SFP+/GE Port

1. Make sure your PC has network access to the SFP+/GE port of OLT.

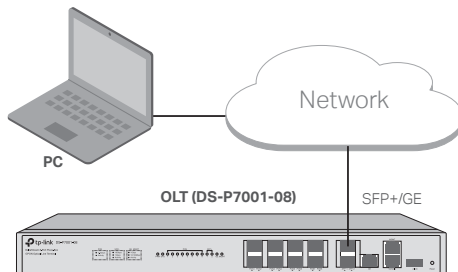



2. Set the IP address of the PC as **192.168.0.x/24** (x is a number between 2 and 254).
3. You can access the device using the Web UI or the CLI.
  - **Using the Web UI:** Open the web browser on the PC. Enter **192.168.0.1** in the address bar to open the web UI of the device. Log in to the web UI. The default username and password are both **admin**. The first time you log in, you are required to change the password for security purposes.
  - **Using the CLI:** Use a telnet or SSH terminal to access **192.168.0.1** to open the CLI of the device. Log in to the CLI. The default username and password are both **admin**. The first time you log in, you are required to change the password for security purposes.

### 4.3 Via the Console Port

---

1. Connect the Console port of OLT to the management PC using an RJ45 console cable.

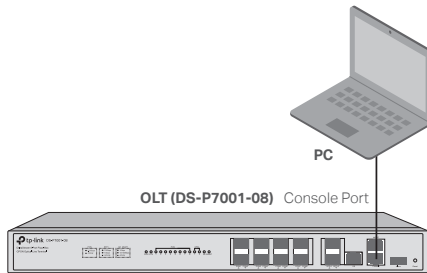

2. Start the terminal emulation program (such as the Hyper Terminal) on the PC and configure the terminal emulation program as follows:

Baud Rate	Data Bits	Parity	Stop Bits	Flow Control
38400 bps	8	None	1	None

# Appendix A Troubleshooting

---

## **Q1. What could I do if I forgot the username and password of the device?**

You can reset the device by holding the reset button for more than 5 seconds. Note that all the configurations will be lost after resetting the device.

## **Q2. Why does the PWR/Power LED work abnormally?**

The PWR/Power LED should be lit up when the power system works normally. If the PWR/Power LED worked abnormally, take the following steps:

1. Make sure that the power cable is connected properly, and the power contact is normal.
2. Make sure the voltage of the power supply meets the requirement of the input voltage of the device.

## **Q3. What should I do if I cannot access the web management page?**

Try the following:

1. Check every port LED on the device and make sure the Ethernet cable is connected properly.
2. Try another port on the device and make sure the Ethernet cable is suitable and works normally.
3. Power off the device and, after a while, power it on again.
4. Make sure the IP address of your PC is set within the subnet of the device.
5. If you still cannot access the configuration page, reset the device to its factory defaults. Note that all the configurations will be lost after resetting the device.

## Appendix B Specifications

---

Item	Content
Standards	IEEE 802.3, IEEE 802.3i, IEEE 802.3u, IEEE 802.3ab, IEEE 802.3ad, IEEE 802.3ae, IEEE 802.3z, IEEE 802.3x, IEEE 802.1p, IEEE 802.1q, IEEE 802.1d, IEEE 802.1s, IEEE 802.1w, IEEE 802.1ah, ITU G.984, ITU G.988
Transmission Medium	10BASE-T: UTP category 3 or above cable (maximum 100 m), EIA/TIA-568 100Ω STP (maximum 100 m) 100BASE-TX: UTP category 5 or above cable (maximum 100 m), EIA/TIA-568 100Ω STP (maximum 100 m) 1000BASE-T: UTP category 5e or above cable (maximum 100 m), EIA/TIA-568 100Ω STP (maximum 100 m) 1000BASE-SX/LX/LX10/BX10: MMF, SMF 10GBASE-SR/LR: MMF, SMF 10GSFP+CU SFP+ Direct Attach Cable (TXC432-CU1M, TXC432-CU3M) GPON SFP
Operating Temperature	0 °C to 50 °C (32 °F to 122 °F)
Storage Temperature	-40 °C to 70 °C (-40 °F to 158 °F)
Operating Humidity	10% to 90% RH Non-condensing
Storage Humidity	5% to 90% RH Non-condensing
Altitude	Sea level to 4,000 m

## EU Declaration of Conformity

TP-Link hereby declares that the device is in compliance with the essential requirements and other relevant provisions of directives 2014/30/EU, 2014/35/EU, 2009/125/EC, 2011/65/EU and (EU)2015/863.

The original EU Declaration of Conformity may be found at <https://www.tp-link.com/en/support/ce/>

## UK Declaration of Conformity

TP-Link hereby declares that the device is in compliance with the essential requirements and other relevant provisions of the Electromagnetic Compatibility Regulations 2016 and Electrical Equipment (Safety) Regulations 2016.

The original UK Declaration of Conformity may be found at <https://www.tp-link.com/support/ukca>

# EAC



Продукт сертифіковано згідно с правилами системи УкрСЕПРО на відповідність вимогам нормативних документів та вимогам, що передбачені чинними законодавчими актами України.

## Safety Information

- Keep the device away from water, fire, humidity or hot environments.
- Do not attempt to disassemble, repair, or modify the device. If you need service, please contact us.
- Place the device with its bottom surface downward.
- The connector on the power supply cord is used as the disconnect device, the socket-outlet shall be easily accessible.
- To avoid damage to the power supply module and the equipment and bodily injury, the product can only be used by instructed persons.
- The equipment must not be used in locations where children are likely to be present.

Please read and follow the above safety information when operating the device. We cannot guarantee that no accidents or damage will occur due to improper use of the device. Please use this product with care and operate at your own risk.



To ask questions, find answers, and communicate with TP-Link users or engineers, please visit <https://community.tp-link.com> to join TP-Link Community.



For technical support, the user guide and other information, please visit <https://www.tp-link.com/support>, or simply scan the QR code.



If you have any suggestions or needs on the product guides, welcome to email [techwriter@tp-link.com.cn](mailto:techwriter@tp-link.com.cn).

